

Leak-Free Load-Control Valve, Size 20

$Q_{\max} = 350 \text{ l/min [92 gpm]}$, $p_{\max} = 420 \text{ bar [6000 psi]}$
leak-proof, two-stage hydraulic, manifold mounting
Series CINDY 20-B-P...

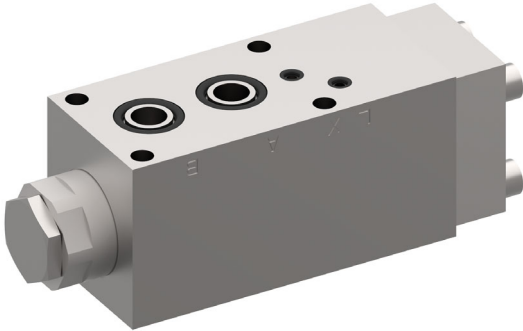

- Two-stage load-control valve and bypass check valve are functionally combined in one coaxial valve assembly
- Leak-free load holding
- Pilot ratio 113:1
- Guaranteed closing force for the load-control assembly
→ reliable shut-off even with a broken spring
- Various pilot-pressure ranges can be chosen
- Satisfies exacting demands on corrosion protection thanks to zinc-nickel coating
- Various types of pilot control are available
- Pressure relief is independent of return-line pressure
- Low-noise operation thanks to specially shaped control grooves

1 Description

Whenever large loads are to be precisely moved, placed and held, or work access platforms must maintain their position and withstand high forces, then leak-free load-control valves from the CINDY series are the right solution. Load-control valves in this series prevent hydraulic actuators from running ahead of the available oil supply. In one

valve, they combine the functions of load-holding, safety and pipe-rupture protection. Leak-free load-control valves in this series are ideally suited for use in high-pressure applications up to 420 bar (6000 psi). With a variety of optional components, the series can be extended and adapted to the requirements of the system.

2 Symbol

2.1 Manifold-mounting variants

Variant A

Influenced by return-line pressure
(pressure in A is additive to opening pilot pressure).

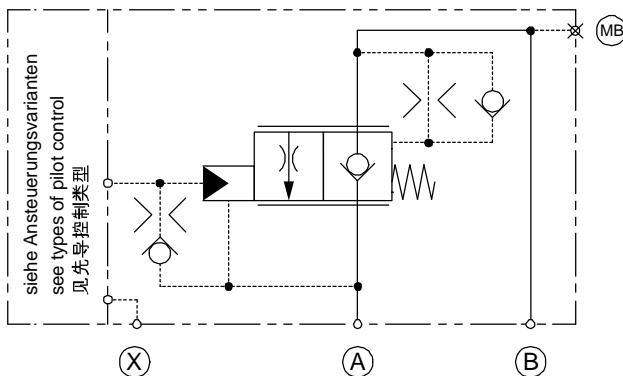

Variant L

Not influenced by return-line pressure
(drain line is required).

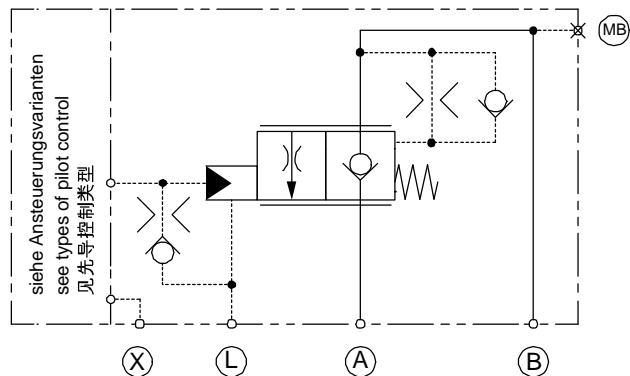

3 Technical data

General characteristics		Description, value, unit	
Designation		Leak-Free Load-Control Valve	
Design		Leak-proof, two-stage hydraulic, manifold mounting	
Size		Size 20	
Mounting method		Flange mounting (4x hex. socket-head cap screws with secondary pressure relief valve (SV): M12x100 without secondary pressure relief valve (SV): M12x75 DIN EN ISO 4762, – grade 12.9)	
Main ports	A, B	∅ 19 mm	[∅ .629 inch] (factory standards)
Tank port	T	∅ 13 mm	[∅ .511 inch] (factory standards)
Control / drain ports	X, L	∅ 4 mm	[∅ .157 inch] (factory standards)
Test ports	MB	G 1/4", ISO 1179-1	
Weight		5.0 ... 6.9 kg	[11.02...15.21 lbs]
Mounting attitude		unrestricted	
Ambient temperature range		- 25 °C ... +100 °C	[-13 °F ... +212 °F] (others on application)
Surface corrosion protection		Zinc-nickel coating Mounting screws zinc-flake coated (e.g. with Geomet® finish)	

Hydraulic characteristics		Description, value, unit	
Maximum operating pressure		420 bar	[6000 psi]
Maximum pressure at the flow- or return port A		420 bar	[6000 psi]
Maximum pressure at the actuator- / load port B		420 bar	[6000 psi]
Maximum pressure at the pilot port X		420 bar	[6000 psi]
Maximum flow rate		350 l/min	[92 gpm]
Flow direction		A → B, free flow through check valve B → A, controlled flow	
Operator type		hydraulic proportional or electro proportional	
Opening pilot ratio		113:1	
Secondary pressure relief valve SVA / SVT		120...420 bar	[1700...6000 psi] setting is factory-sealed (lower settings on request)
Factory setting tolerance of the secondary pressure relief valve		0 ... + 14.0 bar	[0 ... + 200 psi]
Hydraulic fluid		HL and HLP mineral oil to DIN 51 524; for other fluids, please contact BUCHER	
Hydraulic fluid temperature range		- 25 °C ... + 80 °C	[-13 °F ... +176 °F]

Hydraulic characteristics		Description, value, unit	
Temperature rating of seals	NBR	- 25 °C ... + 100 °C	[-13 °F ... +212 °F]
	FKM	- 20 °C ... + 200 °C	[-4 °F ... +392 °F]
	MIL	- 55 °C ... + 80 °C	[-67 °F ... +176 °F]
Viscosity range		2.8... 1500 mm ² /s (cSt), recommended 10...380 mm ² /s (cSt)	
Minimum fluid cleanliness Cleanliness class to ISO 4406 : 1999		Class 20/17/14	

4 Construction and function

The functions of the control assembly are subdivided into the following positions:

4.1 Neutral position

The load pressure and the compression spring act on the control spool in the closing direction. The valve is closed with no leakage.

4.2 Lifting (flow direction from A → B)

The pump pressure at port A opens the valve against the "light" compression spring and the load. The pilot spool and control spool move together in the opening direction. Oil flows from A → B and the valve functions as a check valve.

4.3 Lowering (flow direction from B → A)

The pilot pressure at port X acts on the pilot piston and against the control springs. The pilot spool opens. As a result, the load pressure B is discharged to port A via the metering grooves in the pilot spool. The progressive characteristic of the pre-opening phase ensures that lowering begins smoothly and without jerks.

If the pilot pressure at port X is increased, the pilot spool opens further. The change in the pressure conditions at the control spool means that it follows the pilot spool in the opening direction. The oil flows from B → A.

Neutral position
(Symbol for 4.1)

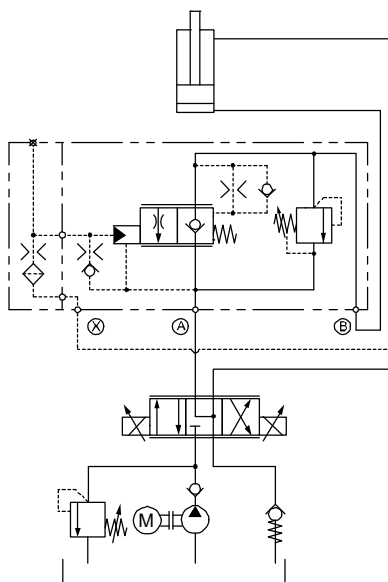

Lifting (A → B)
(Symbol for 4.2)

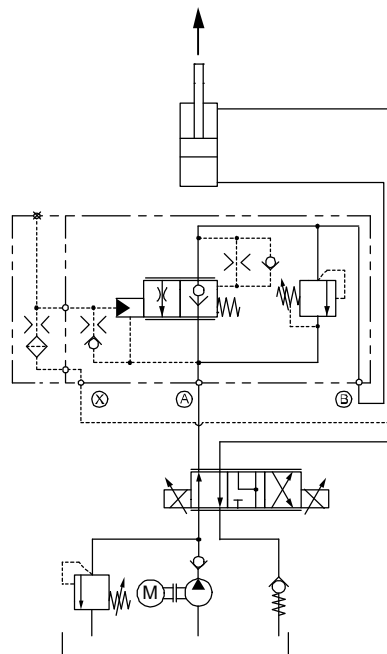

Lowering (B → A)
(Symbol for 4.3)

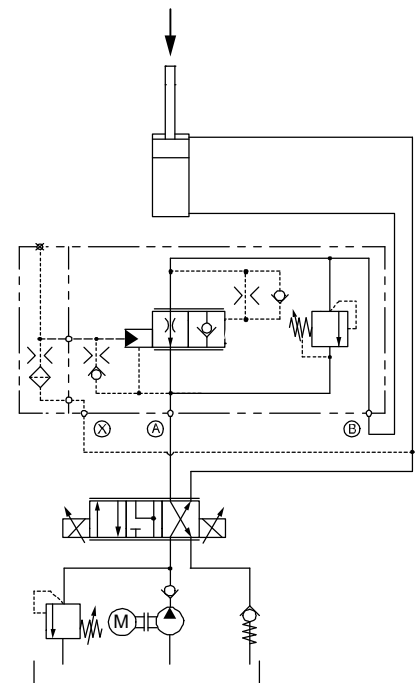

4.4 Types of pilot control

Cover types / applications	Type "G"	Type "D"	Type "K"	Type "H"	Type "E"
Cylinder application (external pilot signal)	✓✓	×	×	✓	✓✓
Cylinder application (pilot signal from opposite line)		✓✓			×
Motors / Winches	×		✓✓	×	×
Motors for slewing drives	×	✓✓	×	×	×

Explanation of symbols: ✓✓ = normal ✓ = possible × = not possible

4.4.1 Standard damping cover, type "G"

Pilot control type "G" is recommended for external control, or with low-oscillation applications. This control cover can only be damped with an inlet orifice. Stroke-dependent damping is not possible with this cover.

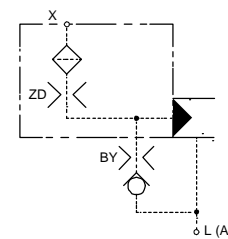

4.4.2 Stroke-dependent damping cover, type "D"

The type "D" cover is recommended for handling pilot signals that come from the opposite actuator line and for applications that are susceptible to oscillations. Thanks to the pilot piston's stroke-dependent damping system, oscillation-prone applications can be started in a very stable manner. The starting pressure peak is reduced because in the starting zone the valve responds quickly to the pilot signal.

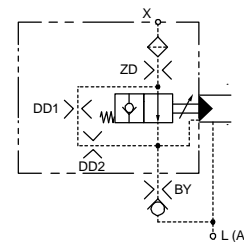

4.4.3 Stroke-dependent damping cover with metering grooves, type "K"

The stroke-dependent damping cover with metering grooves, type "K", is recommended for applications that are susceptible to oscillations, such as hydraulic motors (e.g. winches).

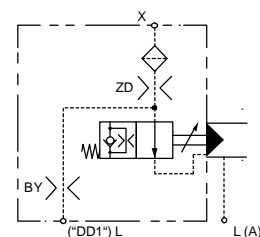

4.4.4 Hydromechanical stroke-limiting cover, type "H"

With the type "H" pilot control, the stroke is limited in order to achieve a particular flow rate or speed. This reduces the valve resolution.

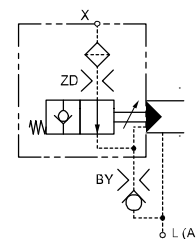

4.4.5 Electroproportional pressure-reducing valve cover Type "E"

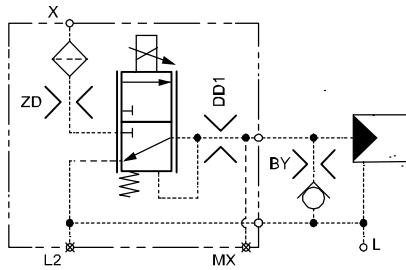

The type "E" control can be used for electroproportional control. In this case, the inlet signal at port X is reduced to a level proportional to the applied control current. The small flow of pilot oil from the pressure reducing valve is led away through an internal drain connection or a separate drain port. This control type is only intended for external pilot oil supplies, and it is essential to use a back-pressure-independent body (L).

Hydraulic characteristics	Description, value, unit	
Pilot-oil supply at X	min. 30 bar max. 350 bar	[min. 435.11 psi] [max. 5076.32 psi] *
Permissible tank pressure at L (static)	max. 5 bar	[max. 72.51 psi]
Flow rate (pump) available at X	min. 2 l/min	[min. 0.528 gpm]
Pilot-oil consumption / Leakage flow rate	< 0.1 l/min (I = 0) < 0.5 l/min (I = max)	[< 0.026 gpm (I = 0)] [< 0.132 gpm (I = max)]
Hysteresis (with PWM control; pulse frequency 100 Hz)	0.5 bar	[7.25 psi]
Pilot-pressure control range	0...20 bar	[0...290.07 psi]

* Other values on request

Electrical characteristics	Description, value, unit	
Nominal voltage	12 V DC	24 V DC
Resistance R 20	5.3 Ω ± 5 %	21.2 Ω ± 5 %
Maximum current at 100% duty cycle	1500 mA	750 mA
Power consumption at operating temperature (with increased resistance)	18 W	18 W
Control current at start of opening	~ 600 mA	~ 300 mA
Control current when fully open	~ 1400 mA	~ 700 mA
Relative duty cycle	100 %	
Insulation class	180 °C (VDE 0580:H)	[356 °F]
Protection class	IP 65 (DIN VDE 0470)	
Connector plug type	AMP Junior Timer Deutsch Plug DT04-2P	



IMPORTANT! Only available in return pressure independent version (L).

General:

The series-connection of the orifices allows the opening time, the closing time, the start of opening, and the full extent of opening to be matched to the requirements of the application.

4.5 Secondary pressure relief valve (SV)

To protect the actuator from overload, a version that includes a secondary pressure relief valve is available. A di-

rect-acting pressure relief valve, type SVT or SVA, for the whole rated flow.



IMPORTANT! With open-centre directional valves, make sure that the valve has an adequate flow rating. If the security seals or other security elements are removed, all Bucher Hydraulics' liabilities become null and void.

4.5.1 Direct-acting secondary pressure relief valve Variant: SVA (B → A)

The SVA direct-acting secondary pressure relief valve is connected directly to the load port B. When the pressure setting is reached, the relief spool opens a flow path to port A, the return line connection.

The relief setting is locked and sealed with a special lock nut.

4.5.2 Direct-acting secondary pressure relief valve Variant: SVT (B → T)

The SVT direct-acting secondary pressure relief valve is connected to the load port B. When the pressure setting is reached, the relief spool opens and creates a connection to the tank port T.

The relief setting is locked and sealed with a special lock nut.

This model is used when the open-centre spool cannot handle the full flow rate, or when the application causes the load to move.

Circuit example for SVA (B → A)
for directional valves with open-centre spool

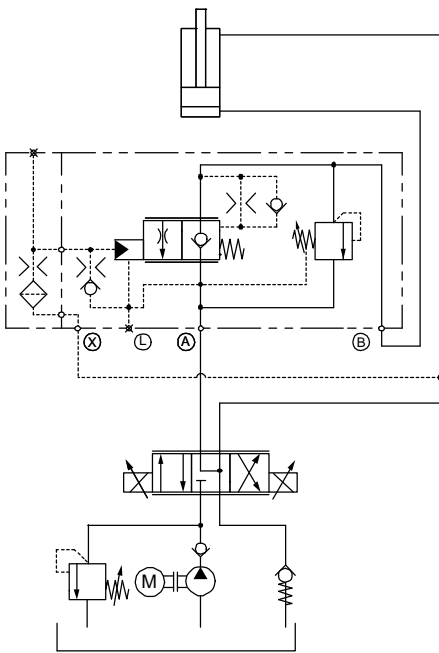

ATTENTION! With body variant A, the return-line pressure is additive 1:1 to the pressure setting (see Fig. at left)! With body variant L, the spring chamber in the pressure relief valve is drained to tank, so the return-line pressure does not affect the pressure setting.

Circuit example for SVT (B → T)
for directional valves with closed-centre spool

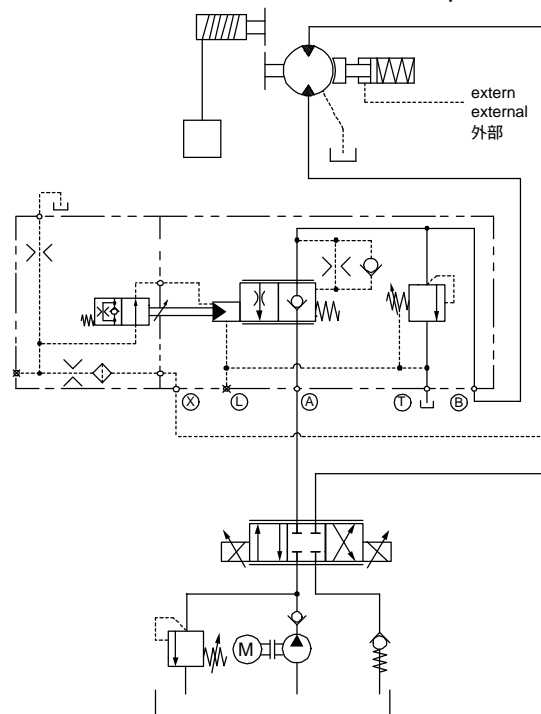

ATTENTION! In the case of a tank-line preload, the pressure is additive 1:1 to the pressure setting!

4.5.3 Overview table for secondary pressure relief valves



IMPORTANT! Please refer to the technical design sheets 300-D-9050101 for cylinder applications and 300-D-9050102 for motor applications.

	SV variants / spool variants	SVA ** Back-pressure dependent (CINDY 20-B-P_-S_-A)	SVA Back-pressure independent (CINDY 20-B-P_-S_-L)	SVT Back-pressure dependent (CINDY 20-B-P_-S_-A)	SVT *** Back-pressure independent (CINDY 20-B-P_-S_-L)
Cylinder applications	Directional valve spool with open centre	✓	✓✓		
	Directional valve spool with closed centre	×		✓	✓
Motor applications *	Directional valve spool with open centre	✓	✓✓		
	Directional valve spool with closed centre	×		✓	✓

Explanation of symbols: ✓✓ = normal ✓ = possible × = not possible

Supplements / Notes:

- * In motor applications, to prevent cavitation at the hydraulic motor it is essential to ensure that sufficient oil is always available at the supply side under all operating conditions!
- ** Return-line pressure from line A is additive to the secondary pressure relief valve's pressure setting!
- *** Leakage/drain gallery (L) is internally connected within the body to the tank gallery (T)!

5 Performance graphs

measured with oil viscosity 33 mm²/s (cSt)

$\Delta p = f(Q)$ Pressure drop - Flow rate characteristic
Lifting A → B

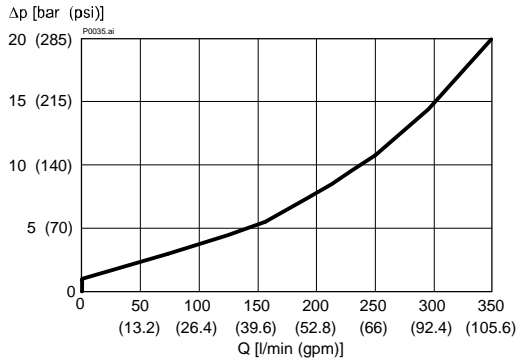

$\Delta p = f(Q)$ Pressure drop - Flow rate characteristic
Lowering B → A

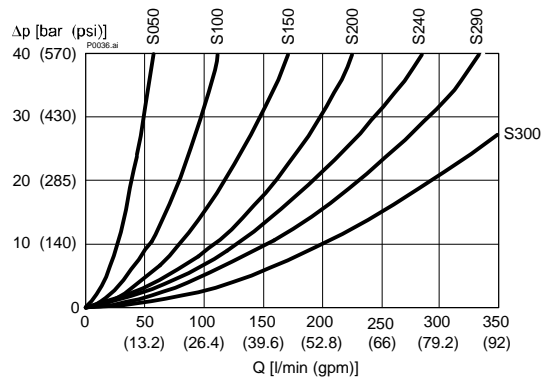

$p = f(Q)$ Pressure - Flow rate characteristic
Secondary pressure relief valve SVA / SVT

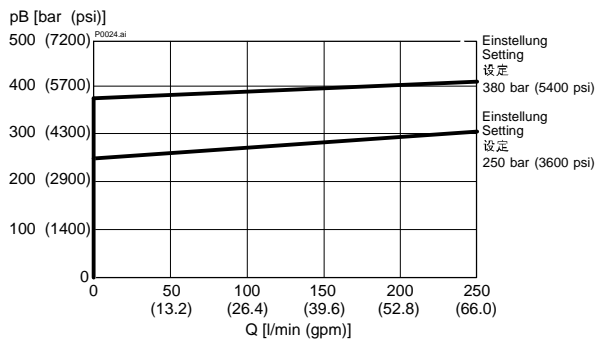

6 Available modules

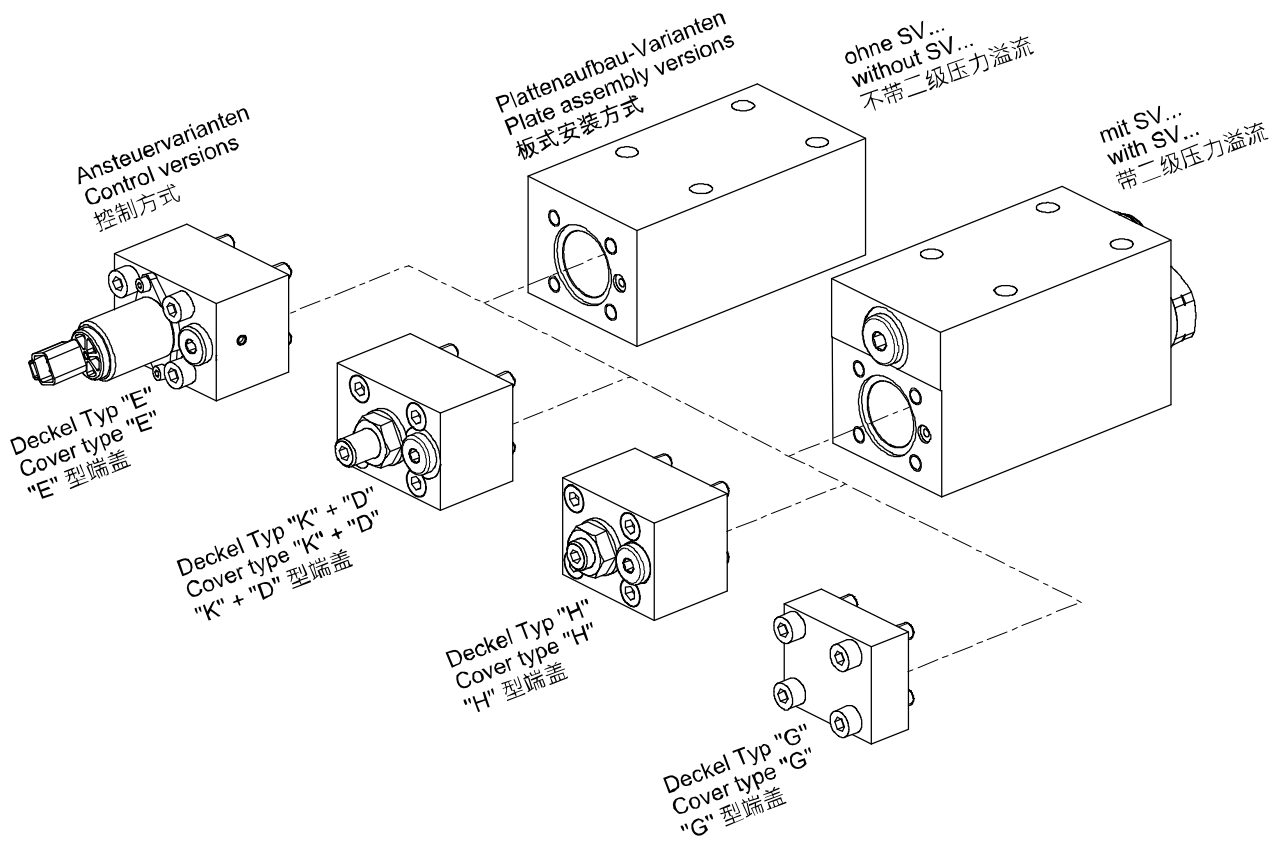

7 Dimensions & sectional view

7.1 Body and control versions

Beispiel für die Masseinheit:
 Example for the dimensional units:
 尺寸单位举例:
 0.79 = 0.79 mm millimeter
 [.031] = 0.031" inch

Standarddämpfungsdeckel Typ "G"
Standard damping cover type "G"
 "G" 型标准阻尼功能端盖

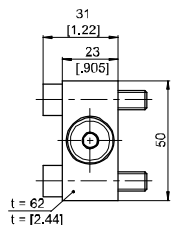

Hubabhängiger Dämpfungsdeckel Typ "D"
Hubabhängiger Kerbdämpfungsdeckel Typ "K"
Stroke-dependent damping cover with metering grooves type "D"
"D" 型行程相关阻尼功能端盖
"K" 型行程相关阻尼功能端盖 · 带沟槽

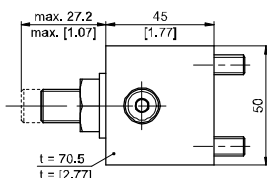

Hydromechanischer Hubbegrenzungsdeckel Typ "H"
Hydromechanical stroke-limiting cover type "H"
"H" 型机-液行程限制功能端盖

* = werkseitige Einstellung
 * = factory setting
 * = 工厂设定

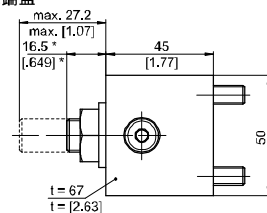

Elektronischer Proportional-Druckminderventildeckel Typ "E"
Electronic proportional pressure reducing valve cover type "E"
"E" 型电比例减压阀功能端盖

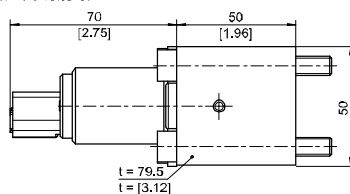

Ohne Sekundärdruckbegrenzungsventil (SVA / SVT)
Without secondary pressure relief valve (SVA / SVT)
不带溢流阀 (SVA / SVT)

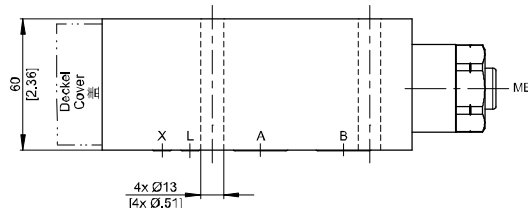
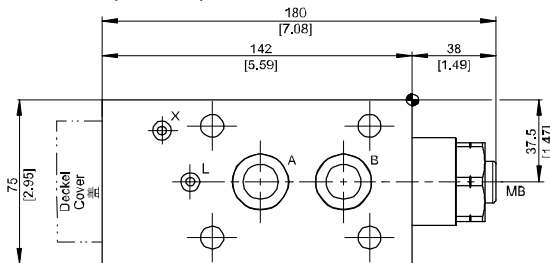

Mit Sekundärdruckbegrenzungsventil (SVA / SVT)
With secondary pressure relief valve (SVA / SVT)
带二级溢流阀 (SVA / SVT)

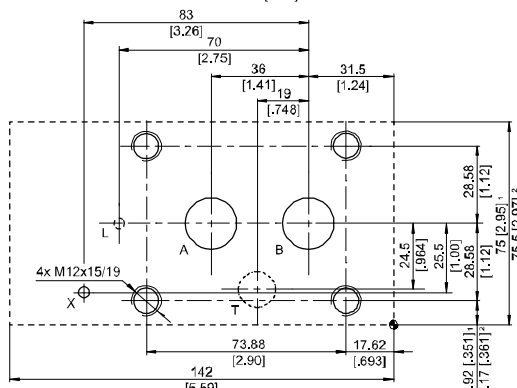
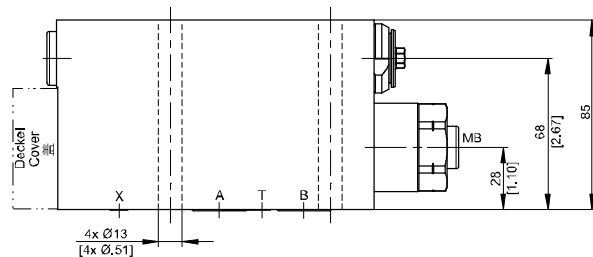
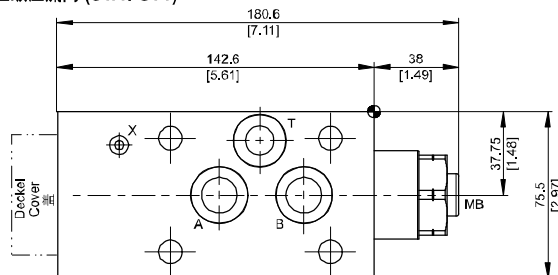

Anschlüsse T und L sind abhängig von der Varianten-Auswahl
 Connections T and L are depend on the variant selection
 T口和L口取决于不同型号选择

1 ohne Sekundärdruckbegrenzungsventil 2 mit SVA / SVT
 1 without secondary pressure relief valve 2 with SVA / SVT
 1 不带溢流阀 2 带二级溢流阀 (SVA / SVT)

Anschlüsse Connections 连接方式	Anschluss Grösse Connection size 连接尺寸	O-Ring am Ventil O-Ring on the valve 网上的O型圈
A	max. Ø 19 [Ø 0.74]	24.99 x 3.53
B	max. Ø 19 [Ø 0.74]	24.99 x 3.53
T	max. Ø 13 [Ø 0.51]	18.72 x 2.62
X	max. Ø 4 [Ø 0.15]	5.28 x 1.78
L	max. Ø 4 [Ø 0.15]	5.28 x 1.78

Toleranzen nach:
 Tolerances according to: DIN ISO 2768-mK
 公差基于:

Erforderliche Oberfläche des Gegenstücks:
 Required surface of the counterpart:
 需要配对的表面:

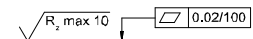

7.2 Interface drawing for mating face

8 Options

8.1 Load-pressure-overcompensated model

This version with compensation orifice (KD) is recommended for long boom systems, e.g. the telescopic booms of mobile cranes. The compensation, alternatively the overcompensation, has the effect of limiting the speed as the load pressure increases, and this in turn raises machine safety levels.

During the lowering function B → A (with a maximum pilot pressure of 19.8 bar), the cylinder's retraction speed is influenced by the compensation orifice KD. In spite of the constantly changing kinematics and the resulting increase in the load pressure, the lowering speed:

- is held almost constant even without a compensation orifice (standard model)
- is reduced with a compensation orifice (overcompensated model)

The compensation orifice in the pilot spool has the effect that, as the load pressure increases, the pressure acting on

the control spool in the closing direction also rises. As a result, the control spool throttles the B → A flow area. To ensure that this function operates properly, these valve types must always be externally piloted.



ATTENTION!:

A prerequisite is that the pilot pressure acting on the pilot piston is limited to max 19.8 bar. A higher pressure will prevent the speed-limiting function from working.



IMPORTANT!:

To ensure that this function operates properly, the back-pressure-independent variant L should be used.

Characteristic curves (examples)

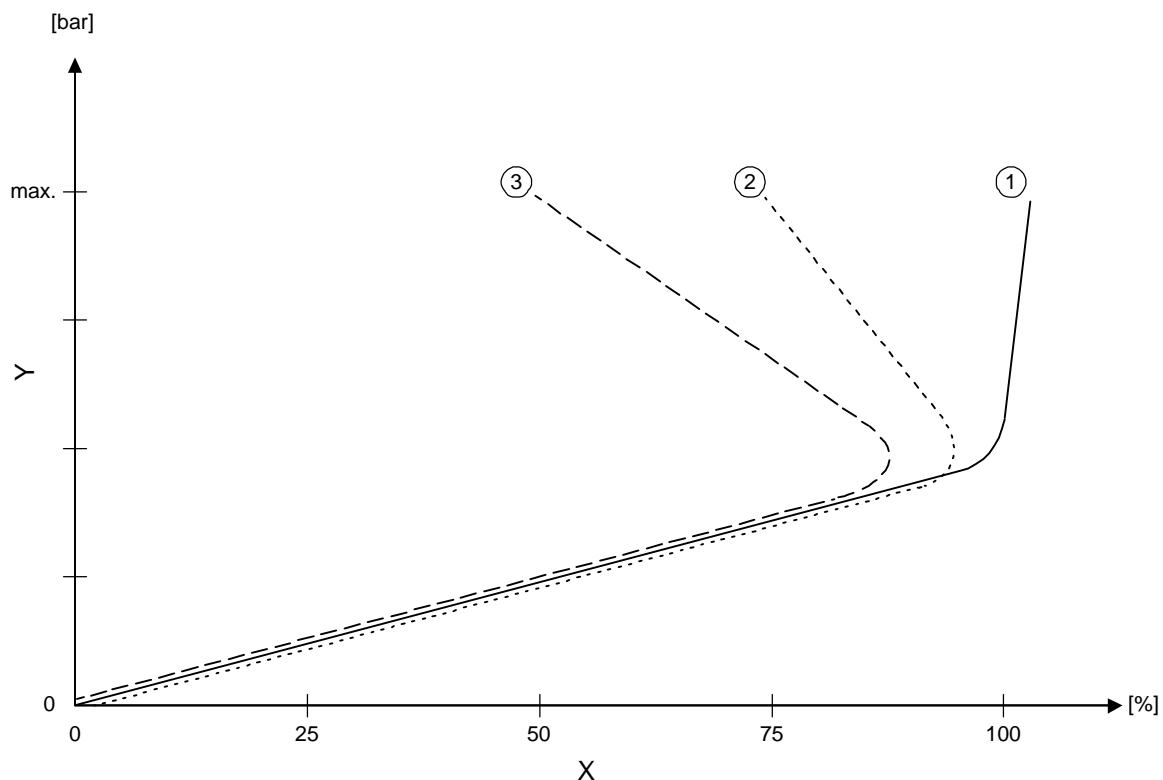

X	Flow B → A
Y	Load pressure

1	Load-pressure-compensated model (without compensation orifice, KD)
2	Approx. 25 % overcompensated (KD Ø 1.8)
3	Approx. 50 % overcompensated (KD Ø 1.5)

9 Safety instructions



IMPORTANT!:

Designing load-control valves requires specialist technical knowledge and product knowledge.

Safety applications must be verified by adequate tests to ensure safety in actual use.

9.1 Assembly / disassembly



IMPORTANT!:

The valve may only be used for its intended purpose within its nominal rating. If you plan to use it outside the nominal rating, you must contact the valve manufacturer. The ultimate responsibility for safety in the installation and use rests with the end-machine manufacturer of the mobile application.



IMPORTANT!:

Seal kit with the external seals is available on application.



IMPORTANT!:

The port threads conform to DIN 3852-2.

Use screws to DIN EN ISO 4762, grade 12.9, to mount the valve.

Tightening torques as per the manufacturer's instructions. These can be found on our website:

www.bucherhydraulics.com

(LOGIntern area; registration required)



IMPORTANT!:

Protect seals and flange faces from damage.

The mating flange face must be of the quality specified in the data sheet!

Pay attention to the port designations.

10 Application examples

10.1 Cylinder application

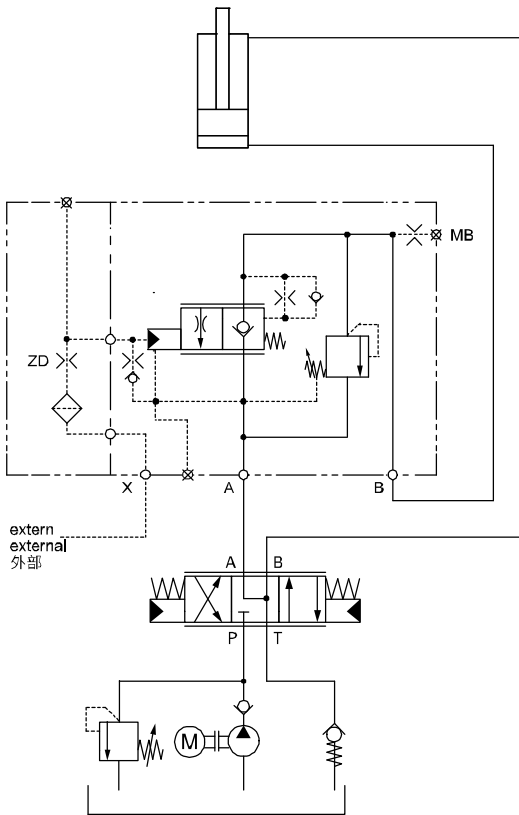

10.2 Motor application

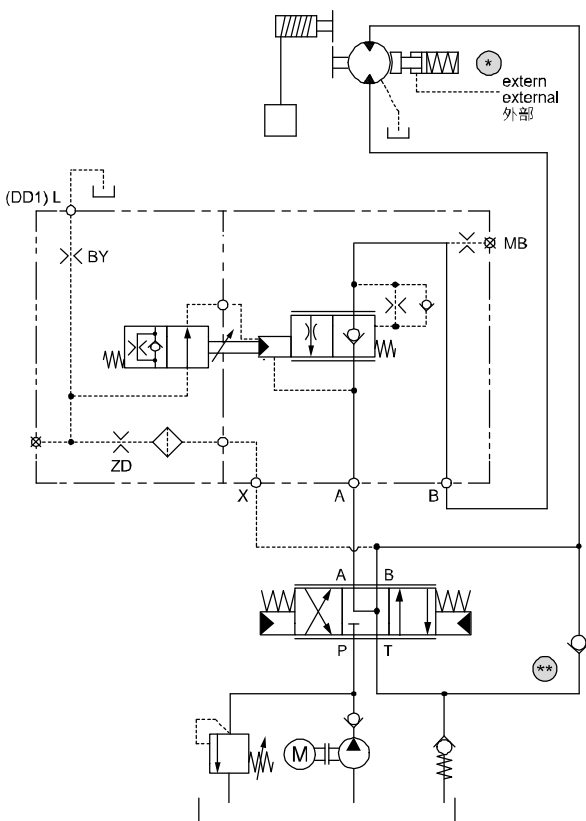

RECOMMENDATION

- * Mechanical brake, externally controlled for reduced lowering pressures in the supply line of the motor.
- ** Anti-cavitation check valve for additional safety.



ATTENTION!

Cavitation danger!

Control from the opposite line:

To open the valve, we recommend control from the opposite line. This method ensures that the actuator cannot run ahead of the incoming flow.

Brake release

(unlocking the mechanical brake):

The mechanical brake must be released before the load-control valve for winches is opened. This prevents draining of the return line to the main spool before the valve opens, thus preventing load fall.

11 Ordering code

e.g. **CINDY** - **20** - **B** - **P** **N** **O** - **S050** - **A** - **G...** - **___** - **...** - **___** - **...**

CINDY = series
 20 = size 20
 B = model / version
 P = manifold mounting
 N = NBR (Nitrile) seals (standard)
 V = FKM (Viton) seals
 T = MIL (low temperature) seals
 O = without mounting screws (standard)
 D = incl. mtg. screws Geomet (ZL) 12.9 DIN 912

S050 = standard spool, B → A 50 l/min [13.20 gpm] *
 S100 = standard spool, B → A 100 l/min [26.41 gpm] *
 S150 = standard spool, B → A 150 l/min [39.61 gpm] *
 S200 = standard spool, B → A 200 l/min [52.82 gpm] *
 S240 = standard spool, B → A 240 l/min [63.40 gpm] *
 S290 = standard spool, B → A 290 l/min [76.61 gpm] *
 S300 = standard spool, B → A 300 l/min [79.25 gpm] *

A = influenced by return-line pressure in A
 L = not influenced by return-line pressure

G... = standard damping cover
 D... = stroke-dependent damping cover
 K... = stroke-dependent damping cover with metering grooves
 H... = hydromechanical stroke-limiting cover
 E... = Electroproportional pressure-reducing valve cover ¹⁾
 ... = orifice combination (is factory-defined)

(blank) = without load pressure overcompensation
 25 = with load pressure overcompensation 25% / compensation orifice KD Ø 1.8
 50 = with load pressure overcompensation 50% / compensation orifice KD Ø 1.5
 52 = with load pressure overcompensation 52% / compensation orifice KD Ø 1.4
 54 = with load pressure overcompensation 54% / compensation orifice KD Ø 1.3

(blank) = without secondary pressure relief
 SVA = secondary pressure relief valve B → A
 SVT = secondary pressure relief valve B → T
 ... = setting of the secondary pressure relief valve
 SVA 120...420 bar [1700...6000 psi]
 SVT 120...420 bar [1700...6000 psi]

*) measured at 33 bar [478 psi] Δp from B → A.

¹⁾ Only available in return pressure independent version (L).

12 Related data sheets

Reference	Description
300-D-9050098	Project Engineering & User Information, Series CINDY, SAE-flange, manifold and cartridge design
300-D-9050102	Technical design sheet for CINDY load-control valves in cylinder applications
300-S-9050015	Spare Parts Information, Series CINDY as manifold design

**IMPORTANT!:**

Additional documentation and 3D models (.stp or .igs format) can be downloaded from www.bucherhydraulics.com (LOGintern area; registration is necessary)

We also offer customised solutions. Please talk to our sales team.

info.ch@bucherhydraulics.com

www.bucherhydraulics.com

© 2023 by Bucher Hydraulics AG, CH-6345 Neuheim

All rights reserved.

Data is provided for the purpose of product description only, and must not be construed as warranted characteristics in the legal sense. The information does not relieve users from the duty of conducting their own evaluations and tests. Because the products are subject to continual improvement, we reserve the right to amend the product specifications contained in this catalogue.

Classification: 430.325.360.315.330.325.305.310